

RIRS P EKO

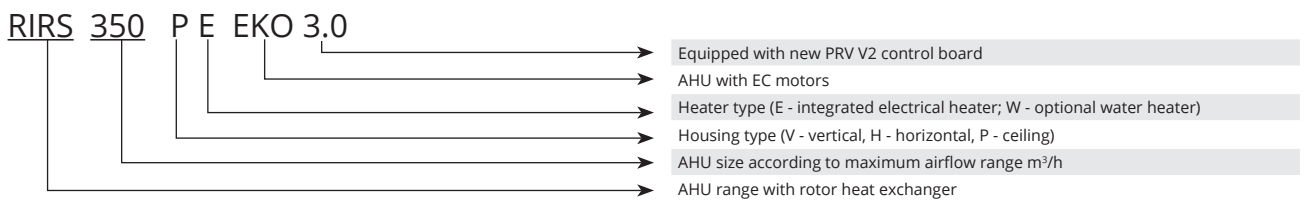

AIR HANDLING UNITS

Application	Ventilation of houses, small public buildings, offices or other heated premises (classrooms, apartments, conference rooms, etc.).
Description	RIRS P EKO 3.0 is a heat recovery unit with high-efficiency rotor heat exchanger and low height. The unit is designed for mounting under ceiling in order to save space. RIRS 350 P unit can come with an optional duct-based water heater or an integrated electrical heater. RIRS P EKO unit has high overall energy savings due to the highly efficient heat recovery (up to 85%), quiet and economical EC fans, effective low pressure drop filters and top-level of air tightness. All RIRS P EKO unit is fully equipped with automatic controls. Optional external sensors for CO ₂ and humidity and so the summer mode feature will guarantee the highest comfort (demand-level control). RIRS P EKO unit is service-friendly and easy to mount. Rotor fault indicator is included in every AHU. All units are supplied tested and ready to install.
Controls	Three remote control options are available: 1. Flex, Stouch or Ptouch remote controllers. 2. Building management system connections. 3. Remote control via PC MB-Gateway.
The main features	<ul style="list-style-type: none"> › Efficient rotor heat exchanger with up to 85% heat recovery. › Water/electrical heating options. › Easy and quick mounting. › Controlled airflow. › Fully integrated plug-and-play control system. › Extremely low height: ideal for ceiling installations.
Rotor	<ul style="list-style-type: none"> › Eurovent certified. › Plate gap 1,5 mm. › Rotor fault indicator. › Minimal airflow mixing.
Construction	<ul style="list-style-type: none"> › Frameless construction from double-skinned steel, with powder coated paint, panels. › Acoustic and thermal wall insulation – 50 mm. › Hinged door with locks grants easy access to internal components. › Separate compartment on the side of the unit grants quick access to the control board (plug-and-play). › Three sensors for fresh, supply and extract air temperatures. › Integrated electrical heater or optional water heater/cooler (on duct). › Water heater with frost protection kit available. › Low pressure drop filters: F7/M5.



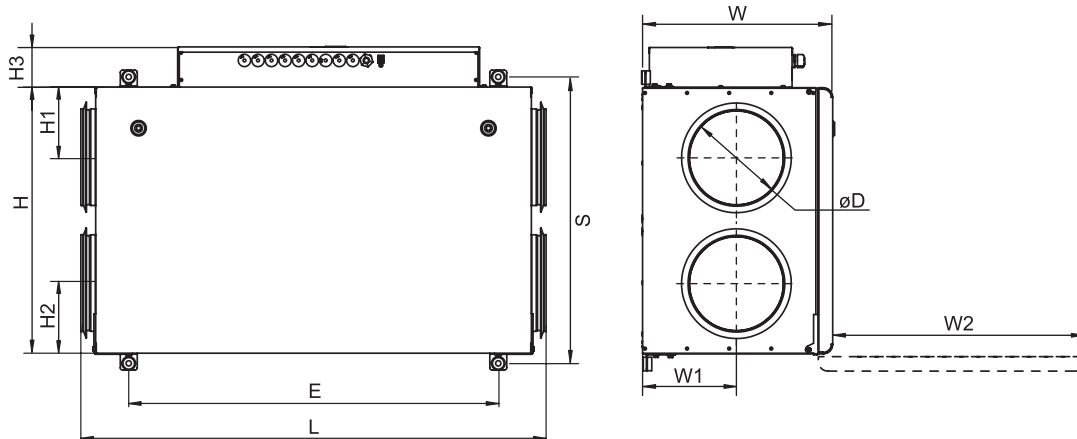















Unit	Dimensions [mm]										
	W	W1	W2	H	H1	H2	H3	E	L	S	øD
RIRS 350PE EKO 3.0	398	196	550	610	160	160	83	764	961	652	200
RIRS 350PW EKO 3.0	398	196	550	610	160	160	83	764	961	652	200

Unit	Optional accessories					
	Flex Stouch Ptouch MB-Gateway	S-1141 S-RC02-F2 S-KFF-U	SP Supply	SP Exhaust	AP SKG	TJP10K C04C***
RIRS 350PE EKO 3.0	+	+	CM230-1-F-L	CM230-1-F-L	200	-
RIRS 350PW EKO 3.0	+	+	TF230	CM230-1-F-L	200	incl

*** - anti-frost thermostat

Unit	Optional accessories							
	SSB Heating	SSB Cooling	RMG 80/60°C	RMG 80/40°C	VVP/VXP 80/60°C	VVP/VXP 80/60°C	AVA	EKA NV PH
RIRS 350PE EKO 3.0	-	81	-	-	-	-	200	200
RIRS 350PW EKO 3.0	61	81	3-0,63-4	3-0,63-4	45.10-0,63	45.10-0,63	200	200

Accessories

Remote controller  Ptouch p. 175	Control panel  FLEX p. 177	Remote controller  Stouch p. 176	Net module  MB-Gateway p. 178	Electrical duct pre-heater  EKA NV PH p. 201	Circular duct water cooler  AVA p. 193		
Pressure transmitter  S-1141 p. 179	CO2 sensor  S-RC02-F2 p. 180	Humidity sensor  S-KFF-U p. 181	Thermic water valve actuator  SSB p. 195	Actuator for dampers  SP p. 210	Duct sensor  TJK-10K p. 182	Mixing point  RMG p. 196	2 and 3 way valves  VVP/VXP p. 197

RIRS P EKO

RIRS 350P EKO 3.0

Supply air

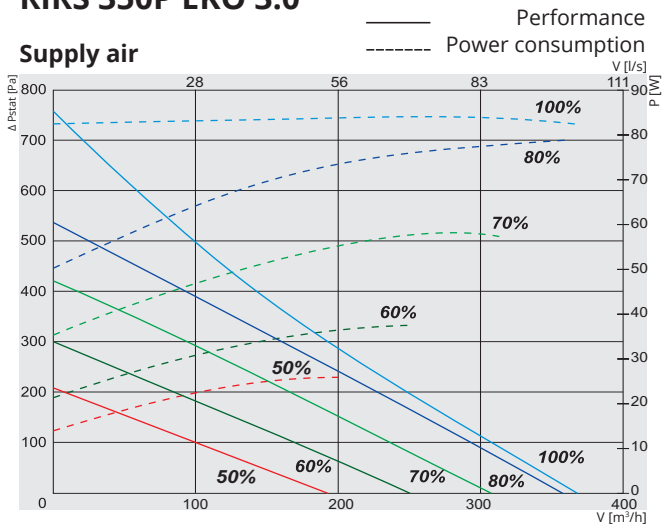

Exhaust air

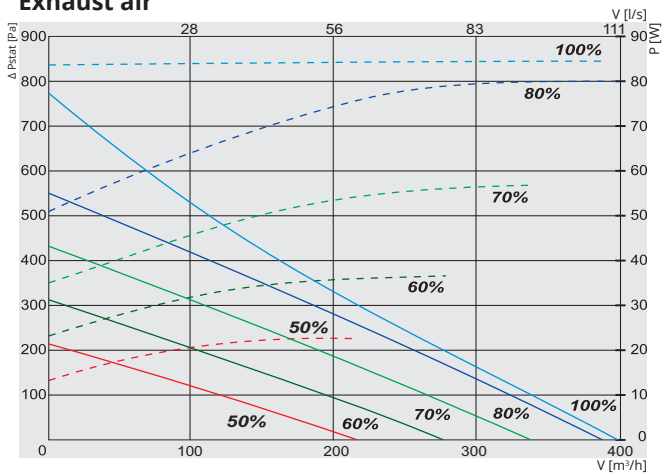

Specific fan power

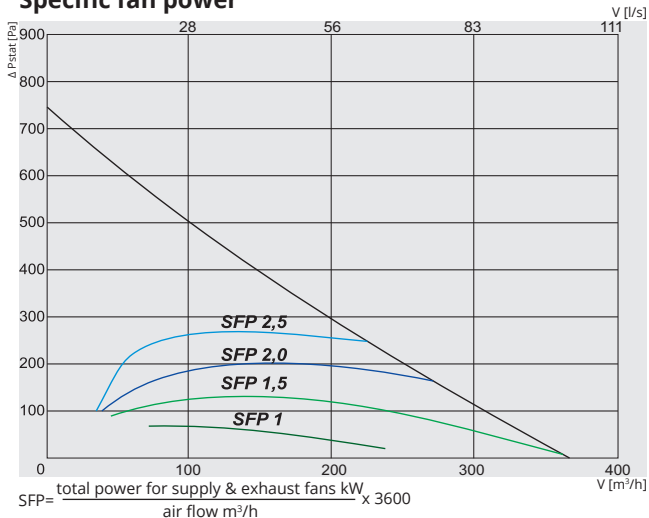

Temperature efficiency

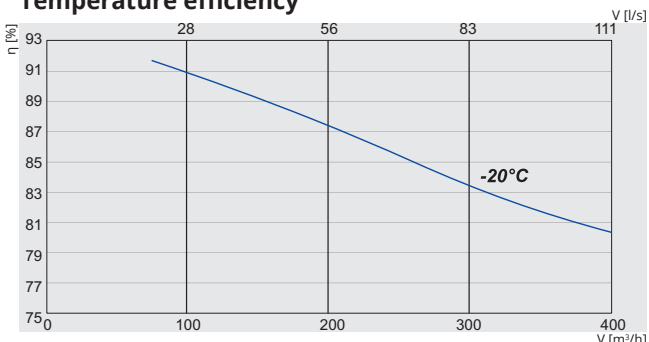

RIRS 350P EKO 3.0
Air intake side (L- left)

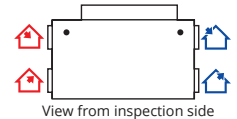

➡ Exhaust air
 ➡ Extract air
 ➡ Outdoor air
 ➡ Supply air

Article No.	Version
GAGRIRS1762_0028A	350PE EKO 3.0 Integrated electrical heater.
GAGRIRS1763_0029A	350PW EKO 3.0 Optional water heater.

350PE / PW EKO 3.0

Water heater (optional) PW ver.	AVS 200
Electrical heater PE ver.	phase/voltage [50Hz/VAC] ~1, 230 [kW] 0,6
EC fans	phase/voltage [50Hz/VAC] ~1, 230
exhaust	power/current [kW/A] 0,083/0,75 fan speed [min ⁻¹] 3200
supply	power/current [kW/A] 0,083/0,75 fan speed [min ⁻¹] 3200
Thermal efficiency up to*	85%
Max power consumption PE / PW	[kW/A] 0,77/4,20 0,18/1,60
Control board	PRV V2
Filter class	exhaust/supply M5/F7
Housing insulation, mineral wool	[mm] 30
Colour	RAL white 9016
Weight (net, without packing) PE / PW	[kg] 54 53
Comply with ERP	2016; 2018
Operation	indoors
Housing protection class	IP 34

* Calculated wet efficiency.

**For temperatures lower than recommended use electrical pre-heater to ensure balanced operation.

Temperature efficiency (balanced mass flow):
Extract air = 20°C/60%RH
Outdoor air = -20°C

350P EKO 3.0	LWA, dB(A)							
	Lwa total, dB(A)	125 Hz	250 Hz	500 Hz	1 kHz	2 kHz	4 kHz	8 kHz
Supply	69	54	53	66	64	60	58	55
Extract	64	52	54	59	58	57	54	49
Surrounding	54	40	39	48	41	47	44	46

Measured at 356 m³/h, 120 Pa

RIRS 350PE EKO 3.0 (ceiling mounted) versions with electrical heater

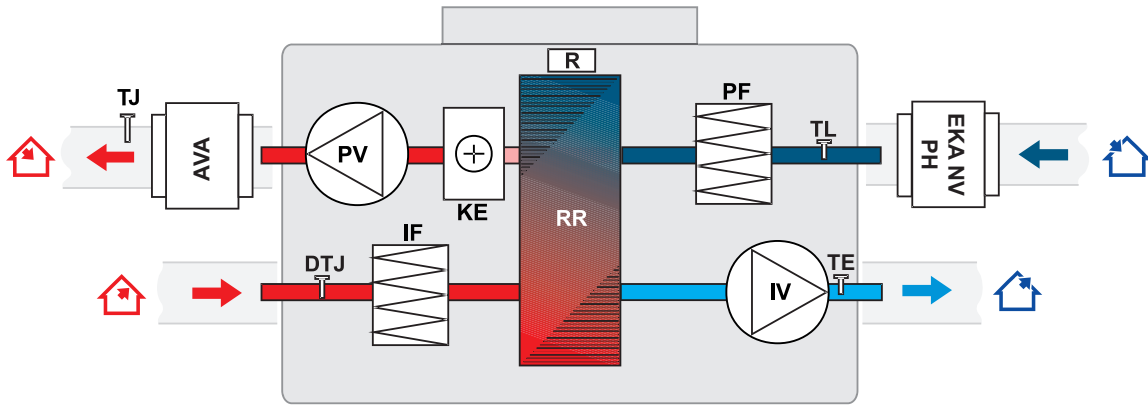

IV - exhaust air fan
PV - supply air fan
RR - rotary heat exchanger
R - rotor motor
KE - electrical heater
TJ - temperature sensor for supply air
TE - temperature sensor for exhaust air

AVA - optionally supplied water cooler
EKA NV PH - optional fresh air pre-heater
PF - fresh air filter (class F7)
IF - extract air filter (class M5)
TL - temperature sensor for fresh air
DTJ - humidity + temperature sensor

RIRS 350PW EKO 3.0 (ceiling mounted) versions with water heater

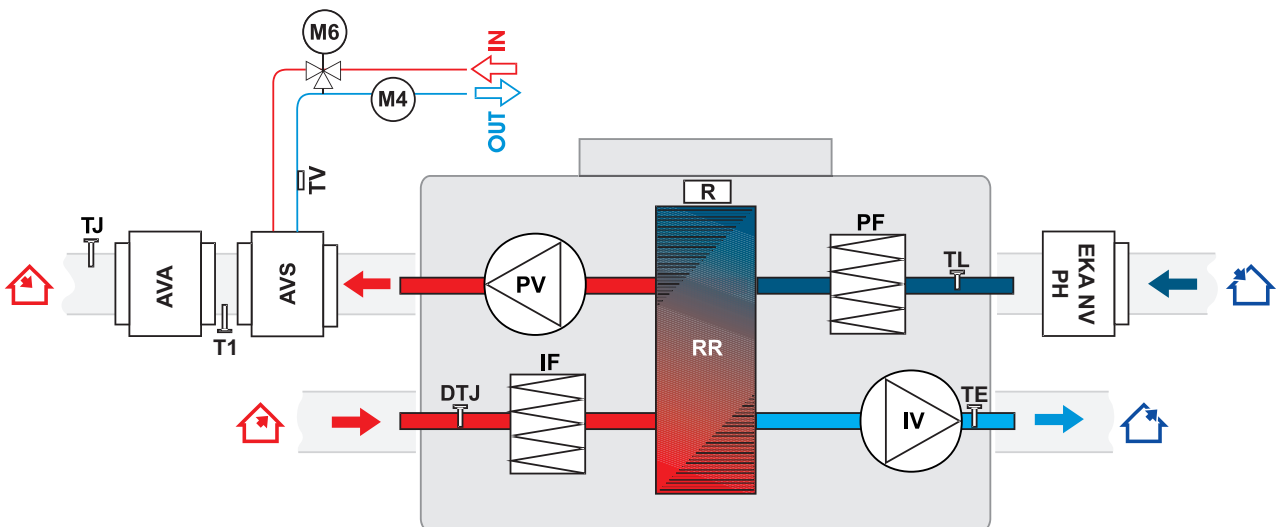

IV - exhaust air fan
PV - supply air fan
RR - rotary heat exchanger
R - rotor motor
PF - fresh air filter (class F7)
IF - extract air filter (class M5)
TE - temperature sensor for exhaust air
T1 - antifrost thermostat
TV - antifrost sensor

AVA - optionally supplied water cooler
EKA NV PH - optional fresh air pre-heater
AVS - optionally supplied water heater
TJ - air temperature sensor for supply air
TL - temperature sensor for fresh air
DTJ - humidity + temperature sensor
M6 - optionally supply mixing valve and motor
M4 - water heater circulatory pump

RIRS P EKO

FUNCTIONS		PRV V2	
Descriptions of the functions	Functions	RIRS EKO 3.0	
		E	W
	Date and time settings	✓	✓
4 speeds for easy and-user friendly control ("Stop" - the unit is stopped; "Low", medium", and "High". Service menu allows adjusting each speed individually)		✓	✓
	BOOST function (Fans operate at highest speed)	✓	✓
	Comfortable air temperature function	✓	✓
	Cold/heat recovery	✓	✓
	Fire place function	✓	✓
	Dryness protection	✓	✓
	Weekly schedule	✓	✓
	Holiday schedule	✓	✓
	User and service control levels	✓	✓
	Manual air flow balancing	✓	✓
	CO₂ level indication and reduction function	✓	✓
	Night cooling function	✓	✓
	Relative humidity (RH) level indication and reduction function	✓	✓
	Software and configuration update possibility	✓	✓
	Supply air temperature control according to the extract air sensor	✓	✓
	Monitoring function (all sensors and I/O)	✓2	✓2
	Mode switch (start/stop)	✓	✓
	Extracted air relative humidity converter	✓	✓
	Manual components control	✓1	✓1
Functional units			
Fans	Soft start and stop	✓	✓
	Fan failure protection	✓	✓
	Speed synchronous/asynchronous 0-10V control	✓	✓
Electric heater	On/Off / PWM control	✓	
	Manual protection	✓	
	Overheat protection (additional protection software)	✓	✓
Water heater	Pulse-width modulation (PWM) valve actuator control		✓
	Protection using temperature sensor		✓
	Protection using thermostat (NC)		✓
	Circulation pump control		✓
	Return water temperature sensor	✓	✓
DX cooler	Control On/Off	✓	✓
Water cooler	Pulse-width modulation (PWM) valve actuator control		✓
	Control with three-positional valve actuator	✓	✓
Filter pollution monitoring	By pressure switch (NC)	✓	✓
	By filter timer	✓	✓
Rotor	Pulse-width modulation (PWM) (0-10VDC) motor control	✓	✓
	On/Off motor control	✓	✓
	Motor belt levers protection	✓	✓
Sensors	Supply air temperature sensor	✓	✓
	Fresh air temperature sensor	✓	✓
	Exhaust air temperature sensor	✓	✓
	Extract air temperature sensor	✓	✓
Emergency signals and inputs/outputs			
	Fire protection input	✓	✓
	Working indication output	✓	✓
	Alarm indication output	✓	✓
Remote controllers			
	Stouch	✓	✓
	Flex	✓	✓
	Ptouch	✓	✓
	MB Gateway	✓	✓
1	With FLEX TEST remote controller	2	Only sensors